

1. Inscribir un triángulo semejante a este:

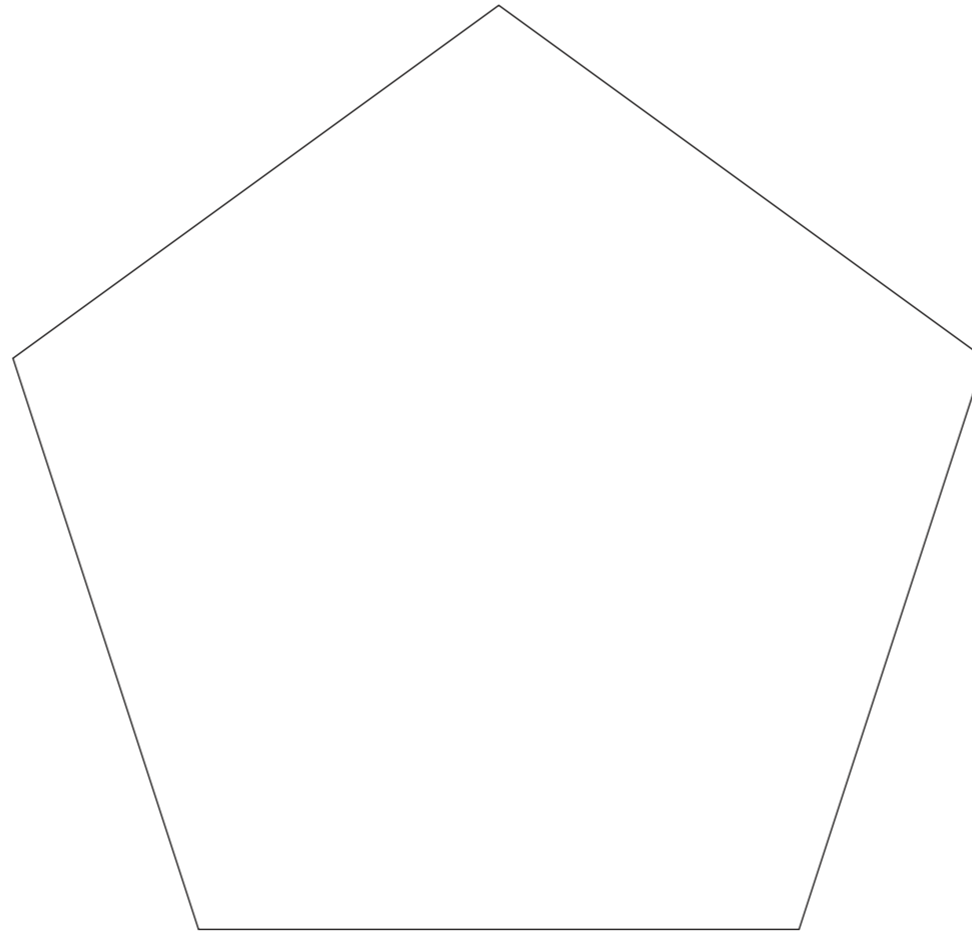

2. Dibujar una figura semejante en una relación de 2/3.

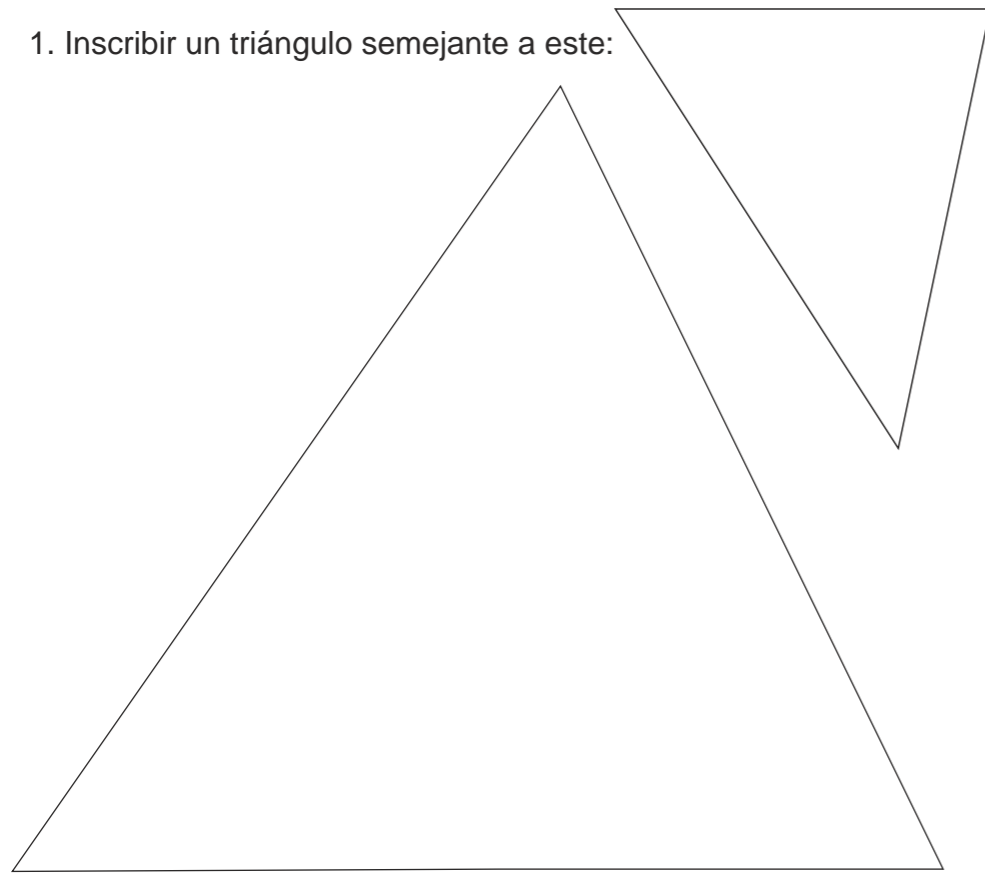
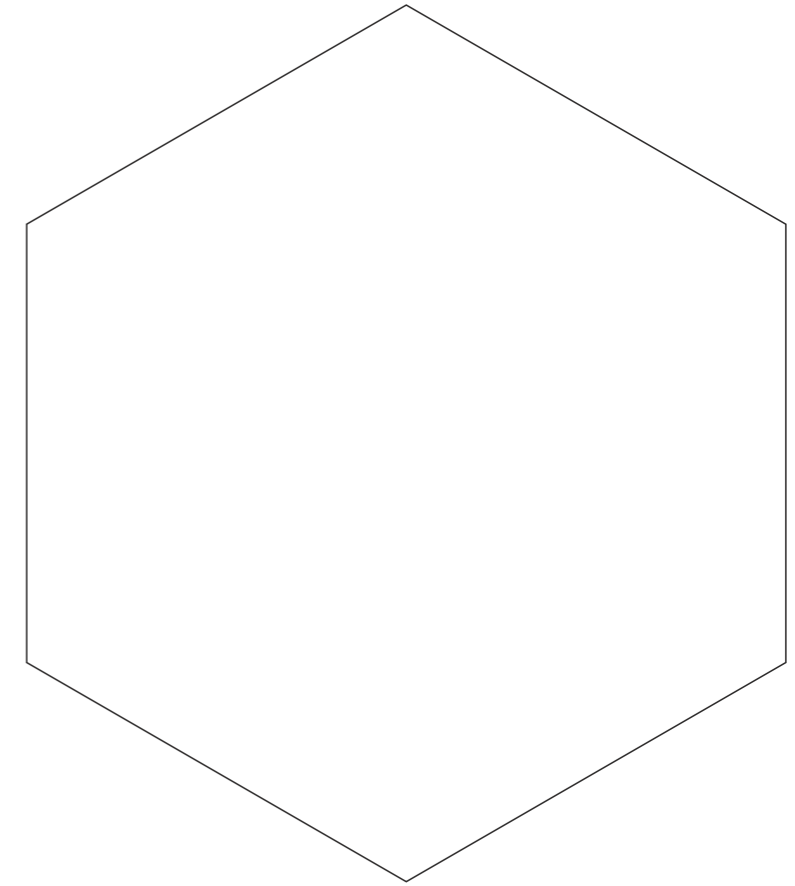

3. Inscribir un cuadrado.

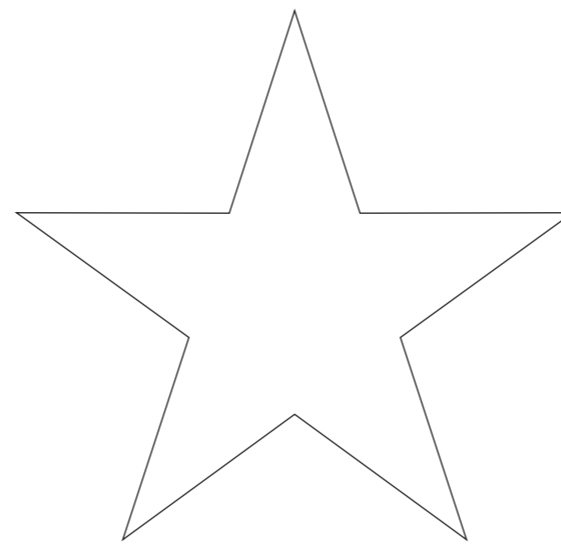
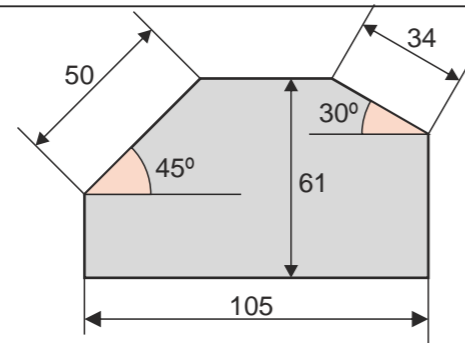

5. Aumentar 3/2.

3. Dibujar una estrella de seis puntas de 33 mm de aspa.

1. Inscribir un triángulo semejante a este:

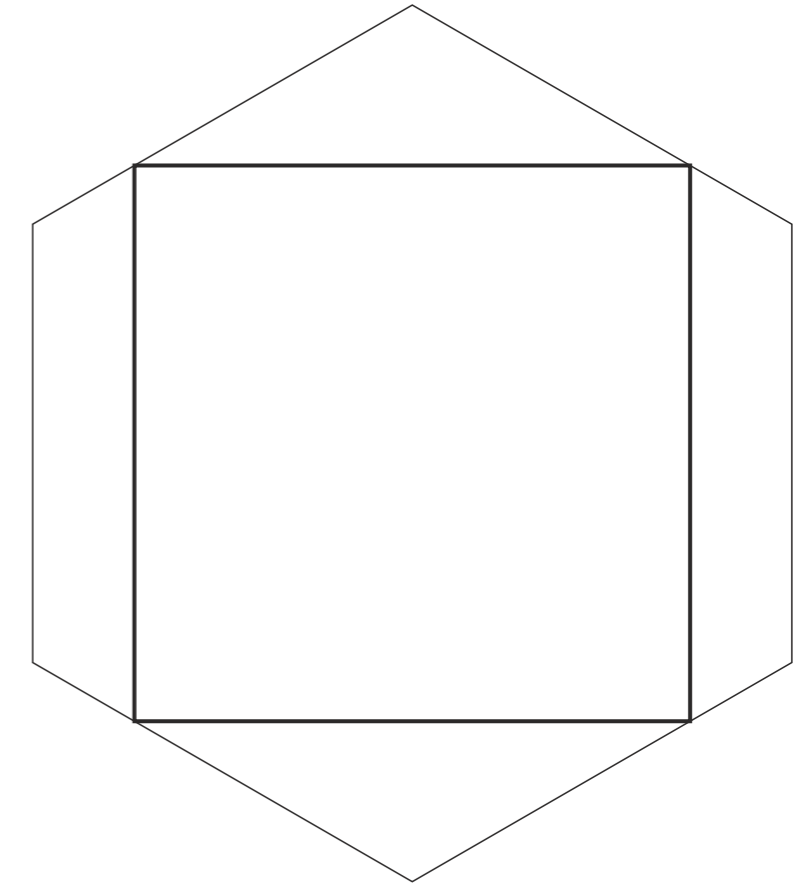
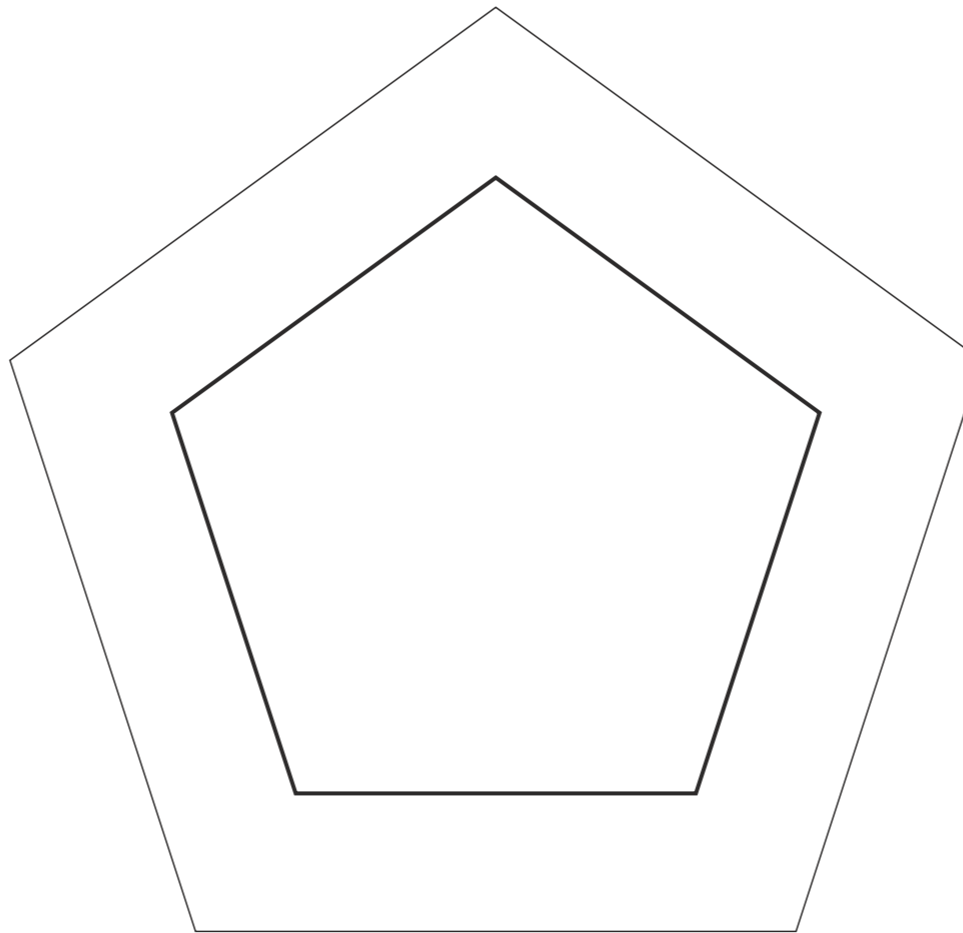
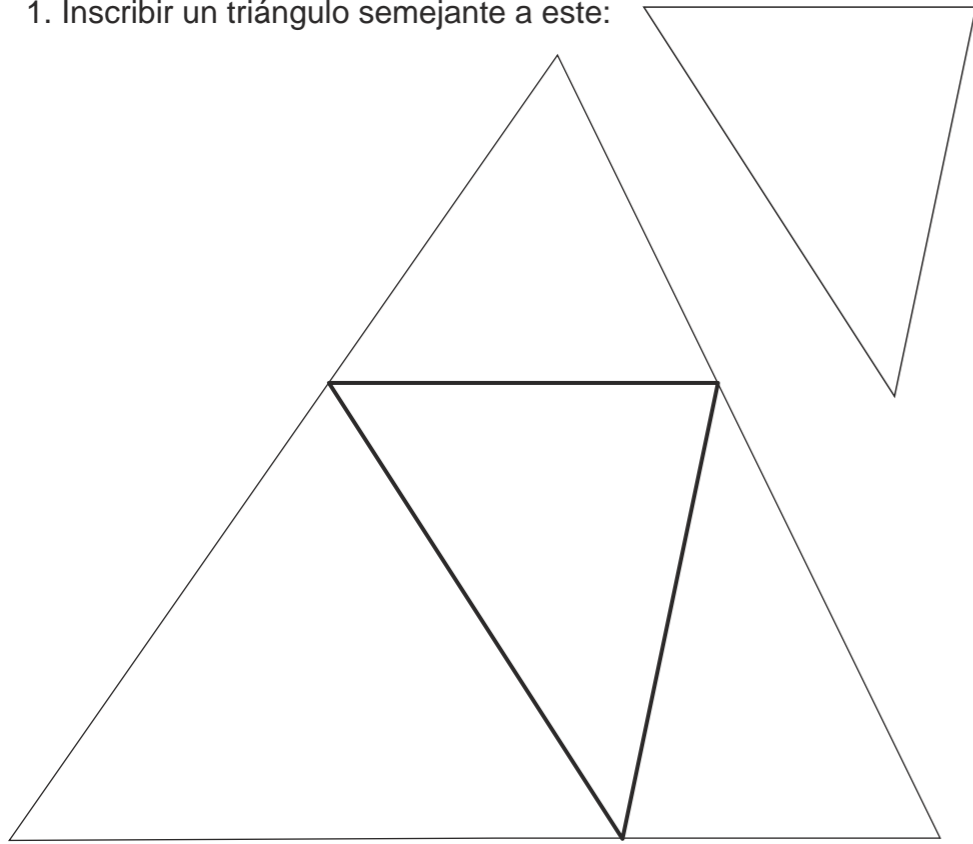

2. Dibujar una figura semejante en una relación de 2/3.

3. Inscribir un cuadrado.

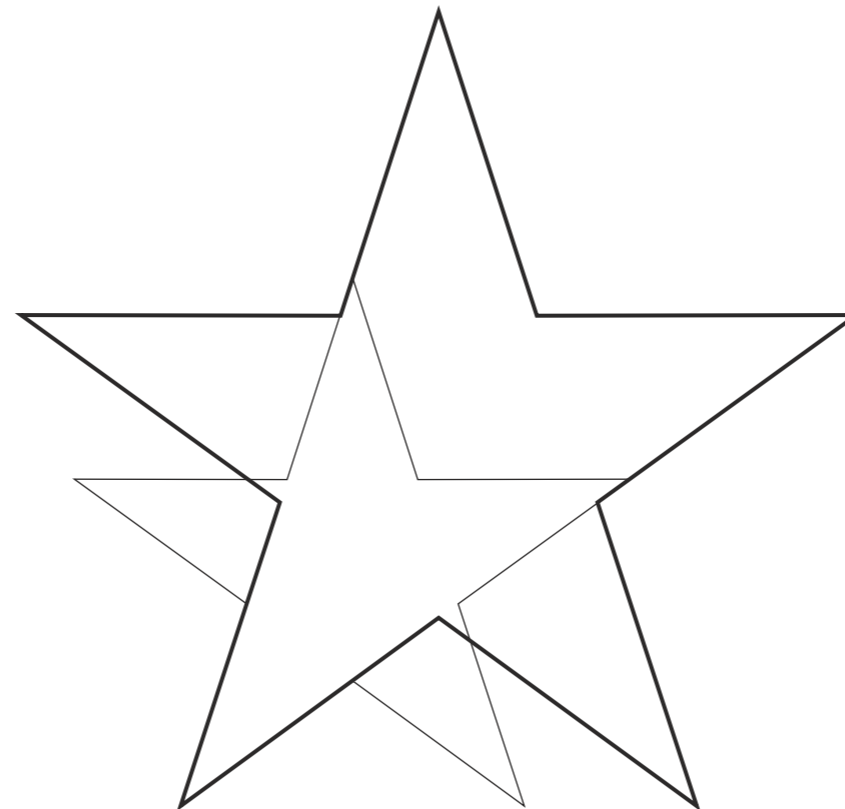
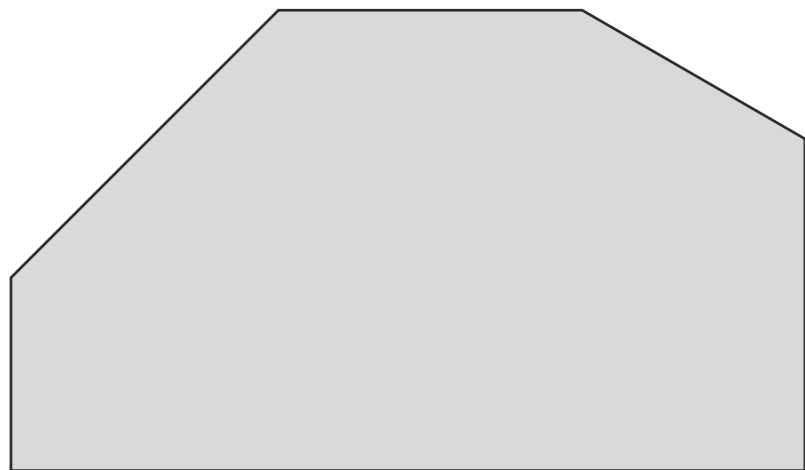
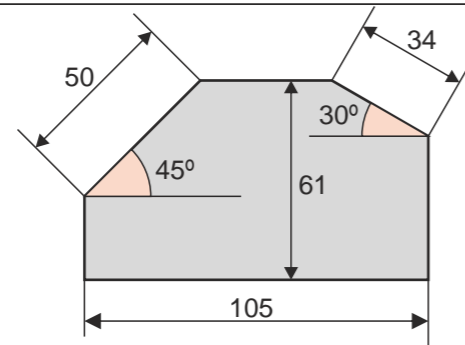

5. Aumentar 3/2.

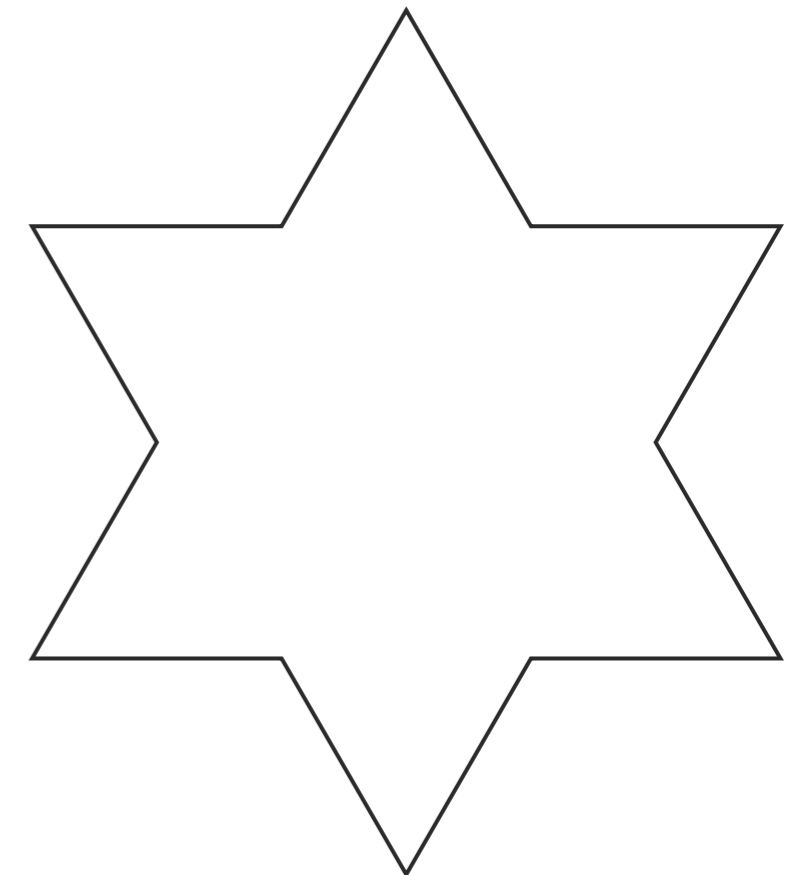

3. Dibujar una estrella de seis puntas de 33 mm de aspa.

1. Inscribir un triángulo semejante a este:

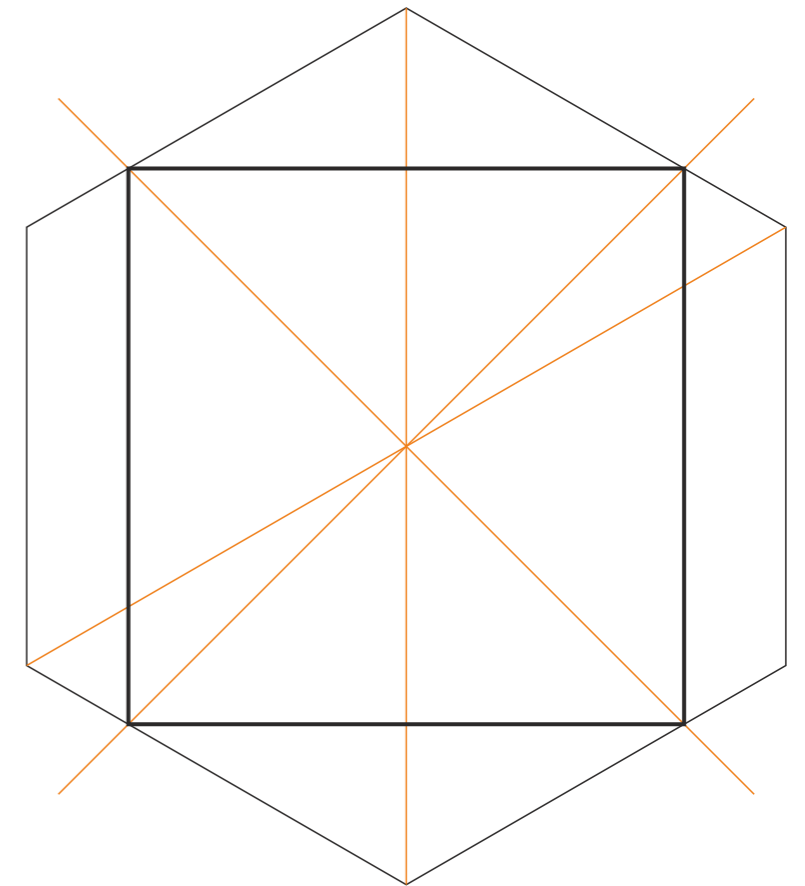
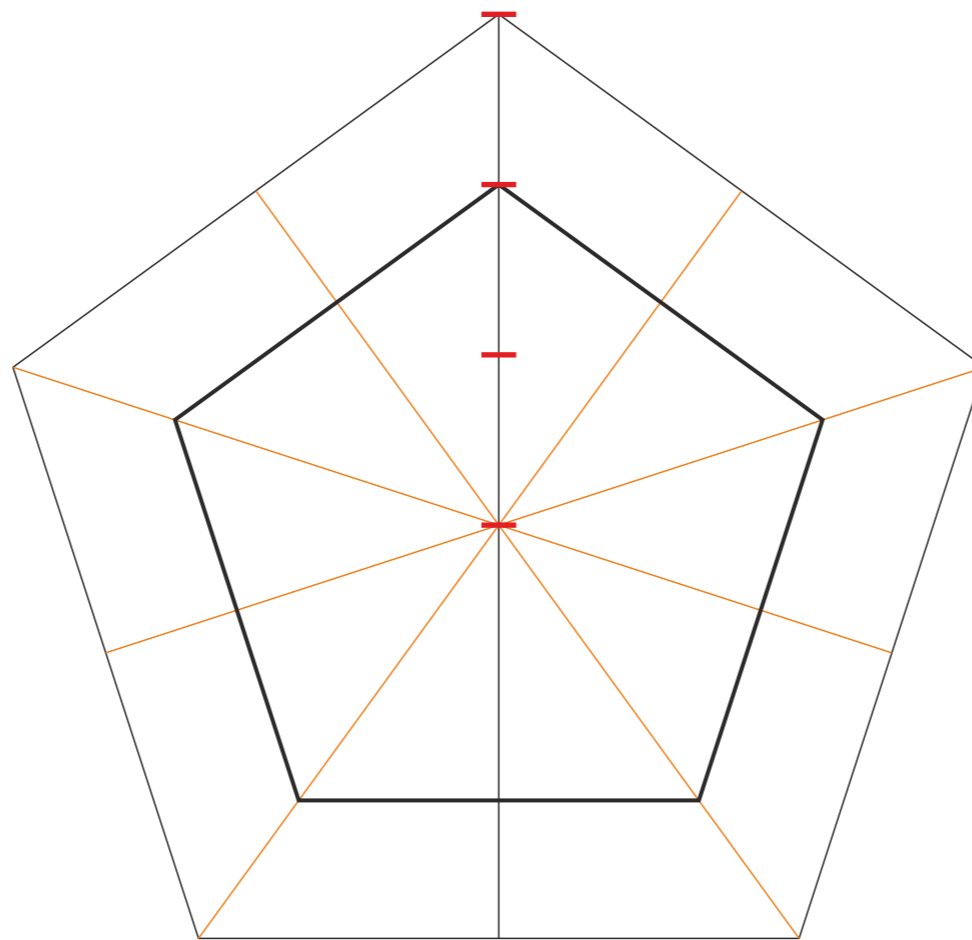
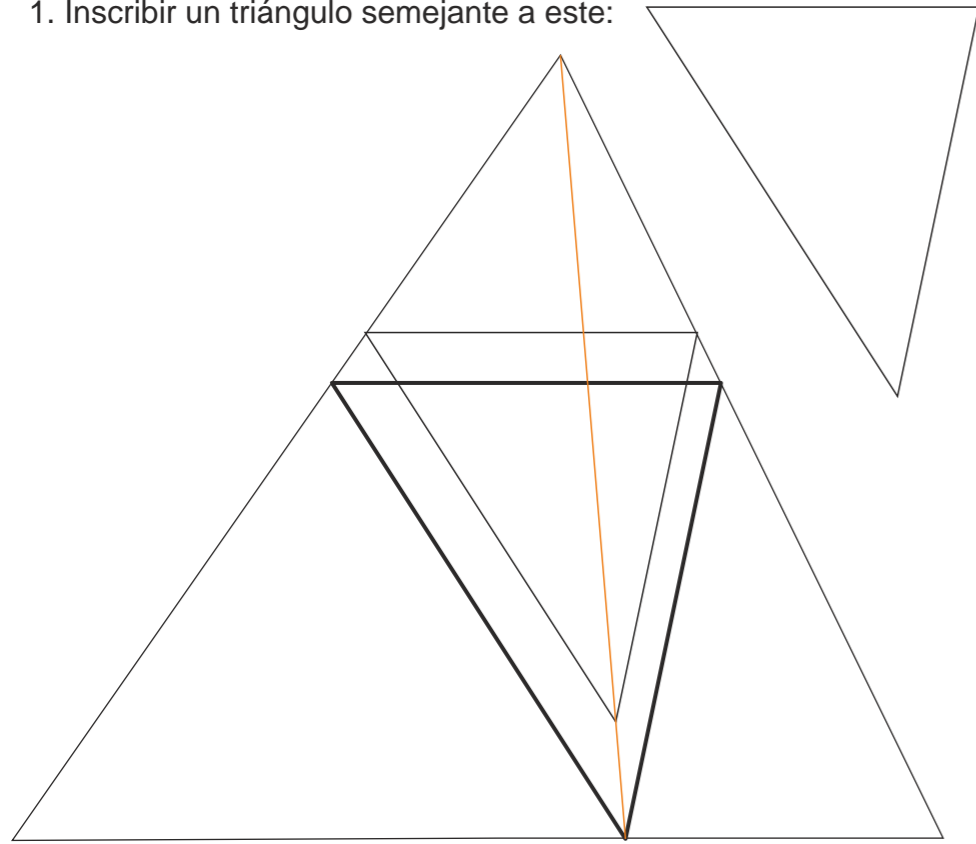

2. Dibujar una figura semejante en una relación de 2/3.

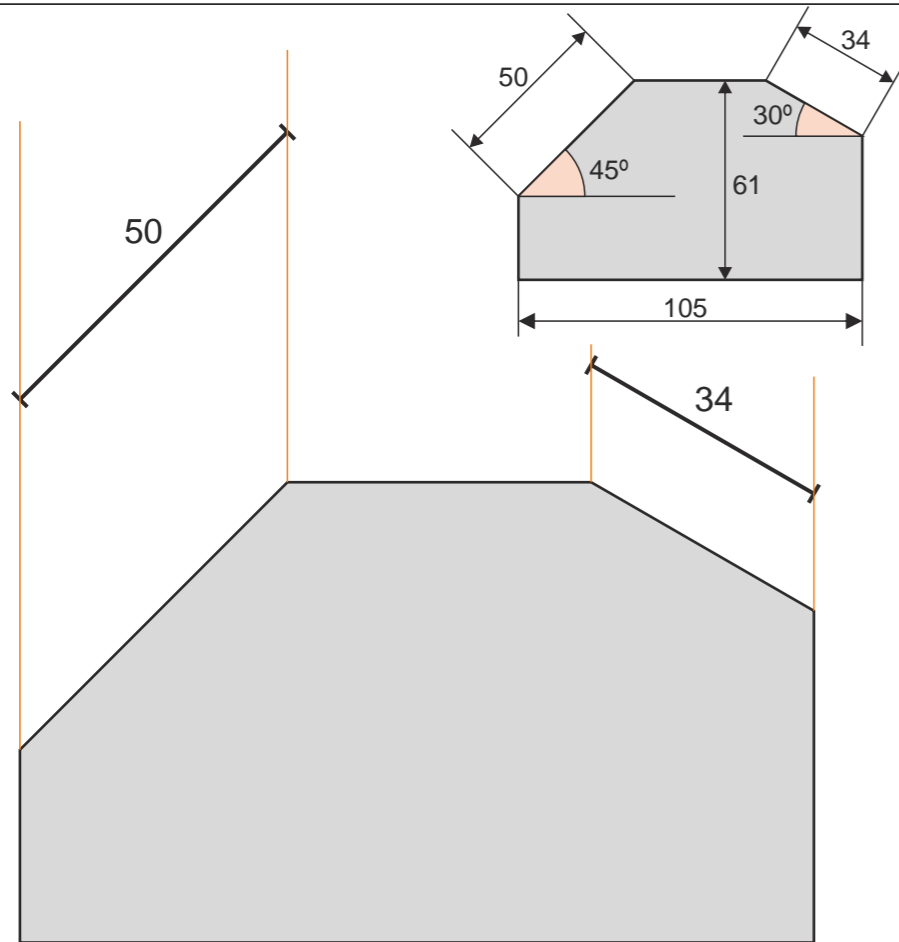

3. Inscribir un cuadrado.

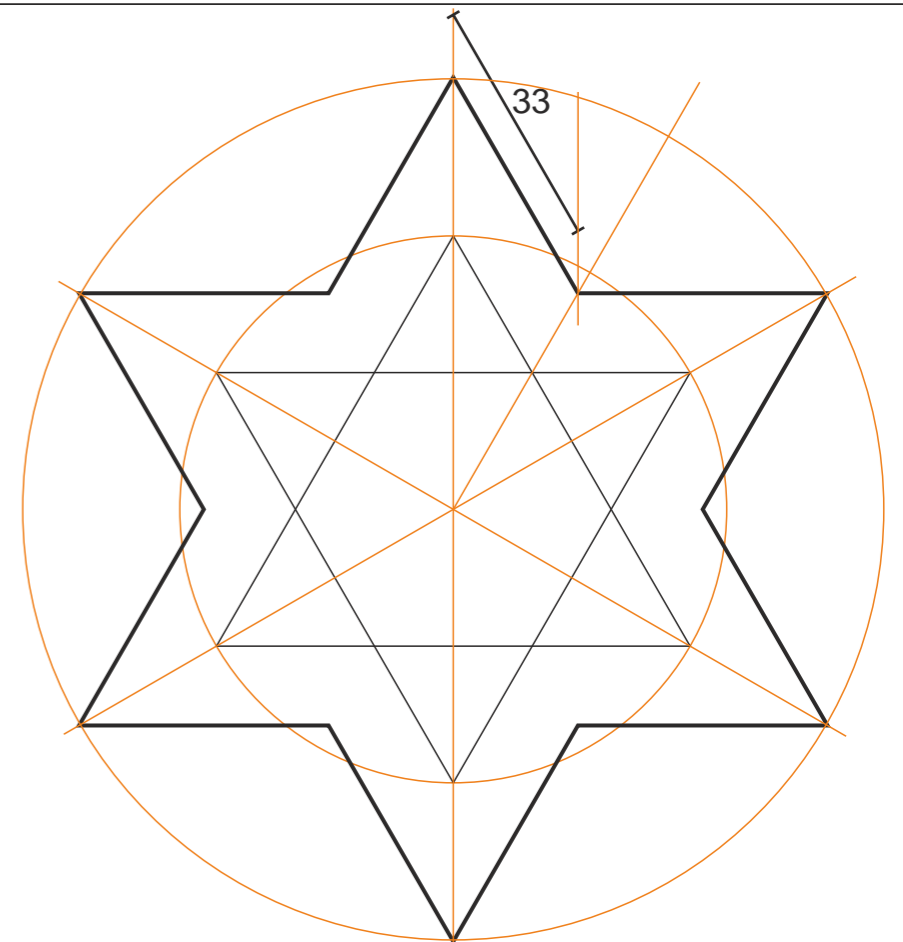
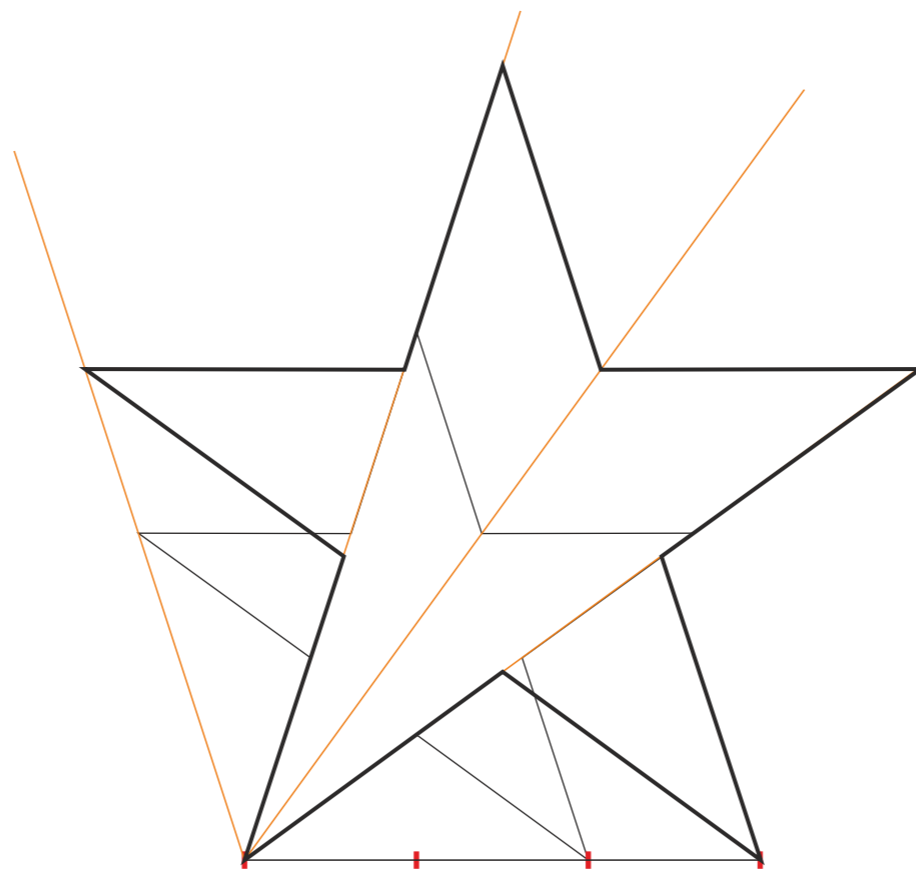

5. Aumentar 3/2.

3. Dibujar una estrella de seis puntas de 33 mm de aspa.